



JOR214 Series

Description

The JOR214 PhotoRelay consist of a MOSFET、 Photoelectric generator optically coupled to an infrared LED 。

Block Diagram and Package

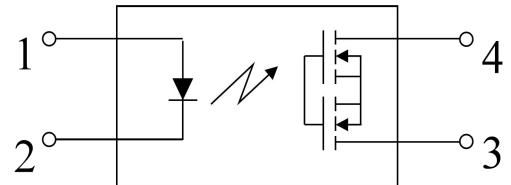

Features

- Normally opened (SPST)
- Control 400V AC or DC voltage
- Switch 120mA load
- Controls low-level analog sings
- High sensitivity, low conductivity resistance
- Low-level off state leakage current
- High isolation voltage 3750V
- Pb free and RoHS compliant



- 1: Anode (LED)
- 2: Cathode (LED)
- 3, 4: Drain (MOS FET)

PACKAGE OUTLINE

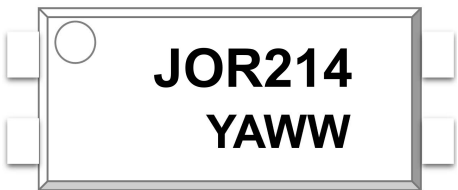

Application

- Communications products (personal computers, laptops)
- Modem/sensor
- Mobile phones/security equipment
- Measuring and testing equipment
- Plant automation equipment
- High-speed inspection machines

ORDERING AND MARKING INFORMATION	
MARKING INFORMATION	
	<p>JOR : Company Abbr. 214 : Part Number Y : Fiscal Year A : Manufacturing Code WW : Work Week</p>
ORDERING INFORMATION	LABEL INFORMATION
<p>JOR214(Y)(Z)-G</p> <p>JOR – Company Abbr 214 – Part Number Y – Lead Form Option (M/S/SL/None) Z – Tape and Reel Option (T1/T2) G – Green</p>	

Absolute Maximum Ratings (TA=25°C)

Parameter		Symbol	Rating	Unit	Note
Input	LED Forward Current	I _F	50	mA	
	LED Reverse Voltage	V _R	5	V	
	Peak Forward Current	I _{FP}	1	A	f=100 Hz, Duty factor= 0.1%
	Power Dissipation	P	75	mW	
Output	Load Voltage (peak AC)	V _L	400	V	
	Continuous load current (peak AC)	I _L	0.12	A	
	Peak load current	I _{peak}	0.3	A	100 ms (1 shot), V _L = DC
	Power Dissipation	P _{out}	300	mW	
I/O isolation voltage		V _{iso}	3750	VAC	
Temperature limits	Operating Temperature	T _{opr}	-40°C ~ +85°C	°C	Non-condensing at low temp
	Storage Temperature	T _{stg}	-40°C ~ +100°C		

Electro-optical Characteristics (Ta=25°C)

Parameter		Symbol	Condition	Min.	Typ.	Max.	Unit
Input	LED Forward current	I_{Fon}	$I_L=0.12A$	0.5	1.8	3	mA
	LED turn off current	I_{Foff}	$I_L=0.12A$	0	1.7	2	mA
	LED dropout voltage	V_F	$I_F=5mA$	1	1.3	1.4	V
Output	On resistance	R_{on}	$I_F=5mA,$ $I_L=0.12A,$ Within 1s on time	0	10	20	Ω
	Off state leakage current	I_{Leak}	$I_F=0mA, V_L=400V$	-	-	1000	nA
Transfer Characteristics	Turn on time	T_{on}	$I_F=5mA, I_L=0.12A$	200	600	2000	us
	Turn off time	T_{off}	$I_F=5mA, I_L=0.12A$	10	700	1000	us
	I/O capacitance	C_{iso}	$f=1MHz, V_B=0$		0.8	1.5	pF
	Initial I/O isolation resistance	R_{iso}	500V DC	1,000			M Ω

Note: LED forward current recommendation value: $I_F=5$ to 10mA

Typical Performance Curves

Fig.1 Load current vs. Ambient temperature characteristics

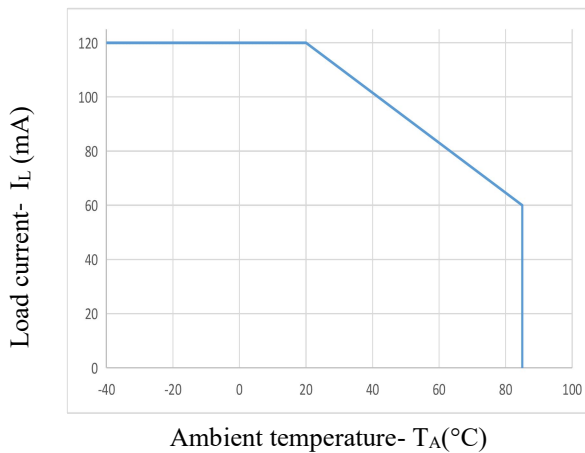

Fig.2 On resistance vs. Ambient temperature characteristics

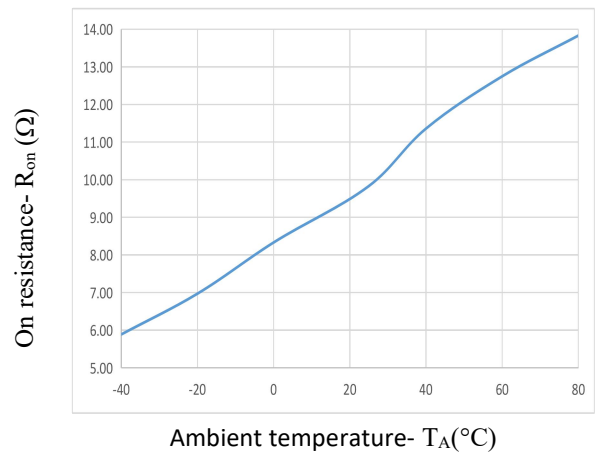

Fig.3 Turn on time vs. Ambient temperature characteristics

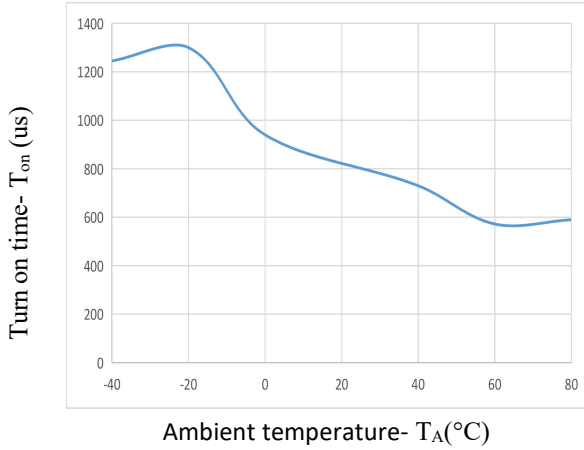

Fig.4 Turn off time vs. Ambient temperature characteristics

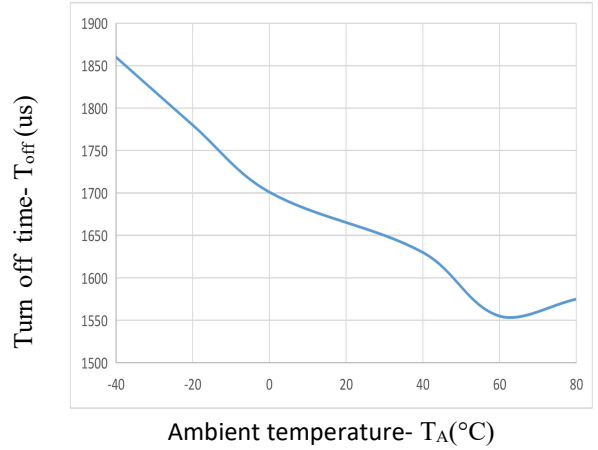

Fig.5 LED Forward current vs. Ambient temperature characteristics

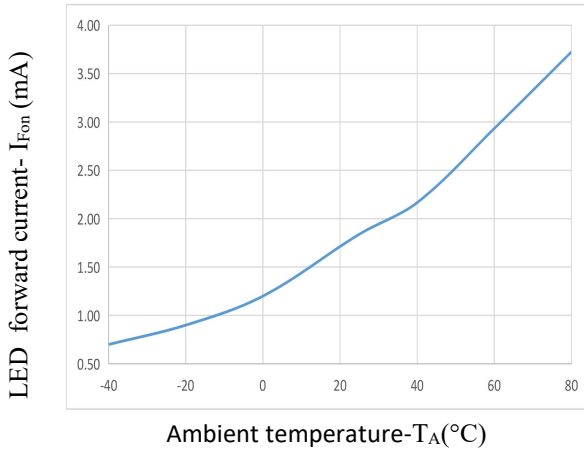

Fig.6 LED turn off current vs. Ambient temperature characteristics

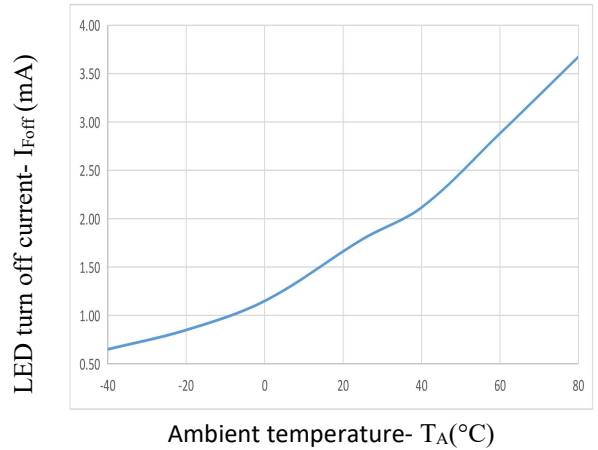

Fig.7 LED dropout voltage vs. Ambient temperature characteristics

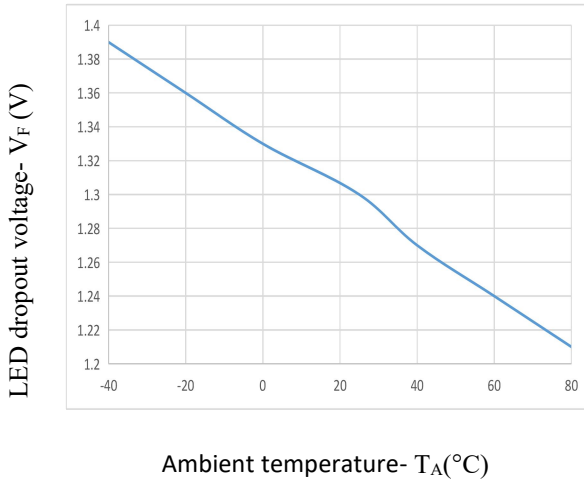

Fig.8 Output current vs Output voltage

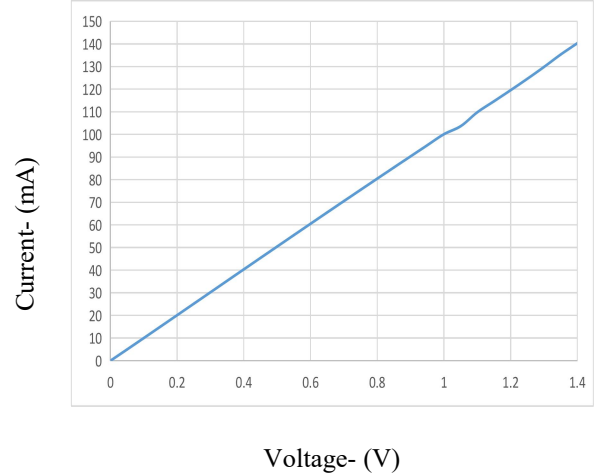

Fig.9 Off state leakage current vs Load voltage characteristics

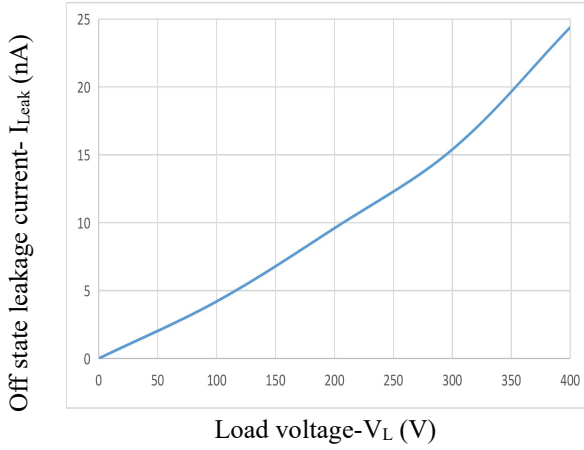

Fig.10 LED turn on time vs Forward current characteristics

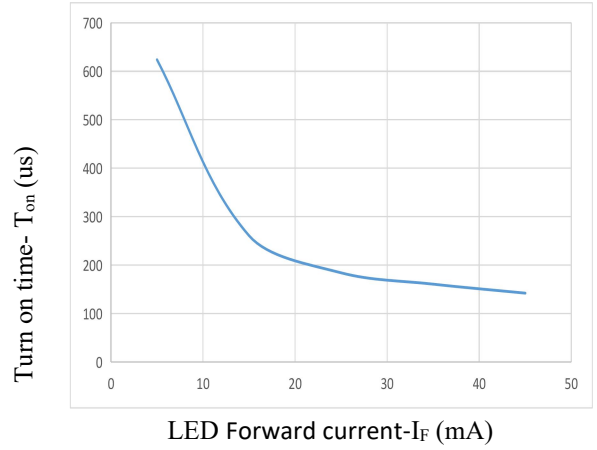
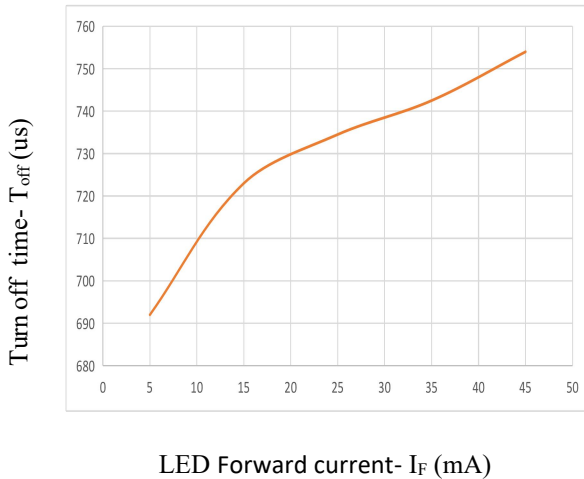
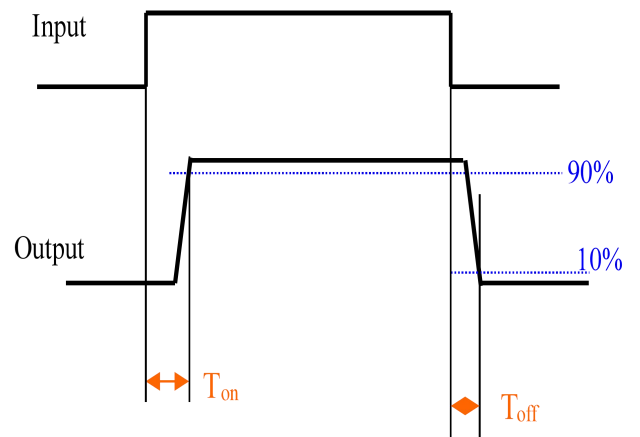

Fig.11 LED turn off time vs Forward current characteristics



★ Turn on/off time



Outline Dimensions

Unit: mm

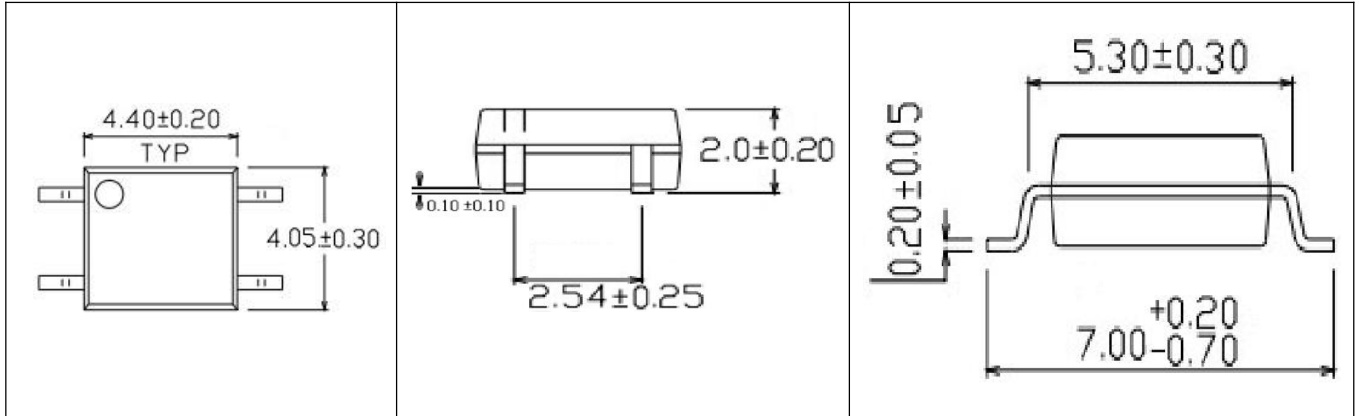

4-pin SOP

Packing

Package Type	Packing Form	Quantity per Reel	Quantity per Box	Quantity per Carton	Antistatic Bag Specification	Box Specification	Carton Specification	Note
SOP-4	Reel (φ330mm Blue)	3k pcs/reel	2 reels /box	10 boxes /ctn	380*380mm	340*60*340mm	620*360*365mm	Guard band 200mm min.

■ SOP-4 (Reel)

- 1) Qty/ctn: 60000 pcs
- 2) Qty/reel: 3000 pcs
- 3) Inner packing: 2 reels /box
- 4) Schematic: (unit: mm)

